



# WorkFit mount WF3K6W

Work desktop station





# PRODUCT OVERVIEW

## **Product Description:**

Dyconn easy to adjust Standing and Sitting Workstation allows the perfect use of working at your desk with the ability to ergonomically work in any position in front of your desk.

Height Adjustable to accommodate for your situation.

## **Product Features:**

- Sit/Stand desk for easy work
- Strong and lightweight
- Easy to assemble and setup
- Perfect size for any desk with height adjustments
- Supports up to 19.84 lbs and 15.75 " of height adjustment
- Dimensions: 20.08"H x 25.2" W x 15.35"L (Depth)

## **Packages Content:**

- Height Adjustable Sit Stand Desk Workstation
- User manual
- Mounting Hardware

# PRODUCT DIAGRAM

## Contents



A. Top cover  
Qty.1



B. Adjustable plate



C. Support plate  
Qty.1



E. Allen wrench 4mm  
Qty.1



F. Philips Screws  
Qty.8



D. Vertical pole  
Qty.4

# INSTALLATION

## Product Dimension

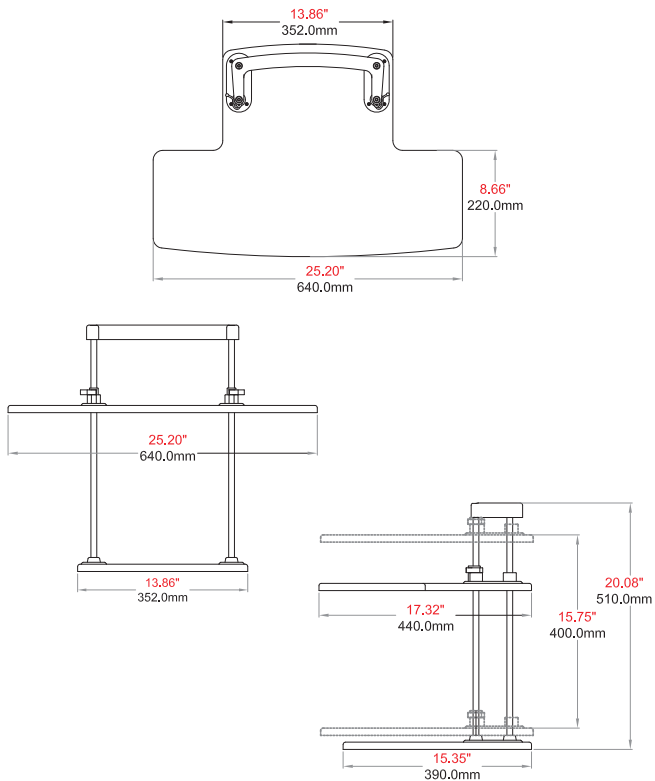

## ASSEMBLY and INSTALLATION:

### Step 1: Installation of vertical poles

1. To insert vertical pole on support plate, to use Allen wrench to tighten the screws at the bottom of screw hole, until vertical poles was fixed.

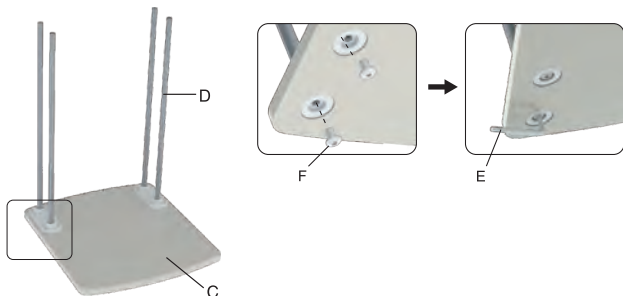

### Step 1: Installation of support plate

1. To lock the handle after support plate been fixed at desire height level.

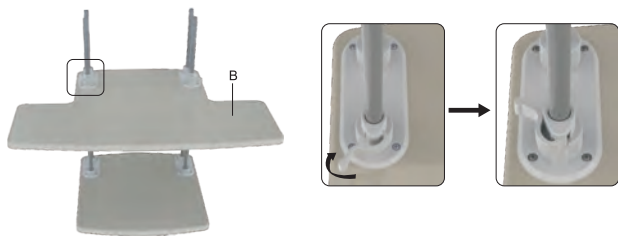

### Step 3: Installation of top cover

1. Use the Allen wrench to tighten up the screws in the screw hole for top cover fitting.

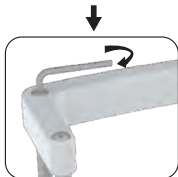
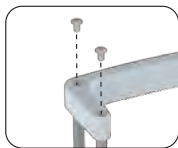
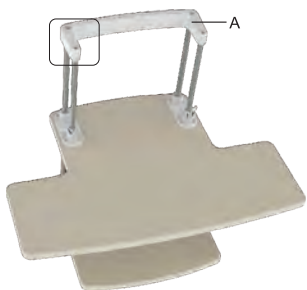

### Step 3: Desktop height adjustment

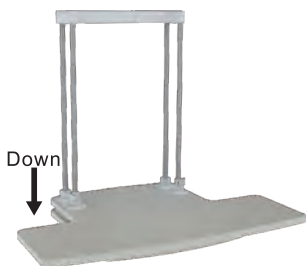

Desktop height adjustment within 400mm.

# DYCONN LIMITED WARRANTY

DYCONN warrants only to the original purchaser of this product from a Dyconn authorized reseller or distributor that this product will be free from defects in material and workmanship under normal use and service for (1) one-year after date of purchase. Purchaser must present acceptable proof of original ownership (such as original receipt, warranty card registration, on-line registration, or other documentation Dyconn deems acceptable) for the product. DYCONN, at its option, shall repair or replace the defective unit covered by this warranty. In order to keep this limited warranty in effect, the product must have been handled and used as prescribed in the instructions accompanying this warranty. This limited warranty does not cover any damage due to accident, misuse, abuse or negligence. This limited warranty is non-transferable and does not apply to any purchaser who bought the product from a reseller or distributor not authorized by Dyconn, including but not limited to purchases from internet auction sites. This warranty does not affect any other legal rights you may have by operation of law. Contact DYCONN at 1-(855) 839-2666 for warranty service procedures.

DISCLAIMER OF WARRANTY EXCEPT FOR THE LIMITED WARRANTY PROVIDED HEREIN, TO THE EXTENT PERMITTED BY LAW, DYCONN DISCLAIMS ALL WARRANTIES, EXPRESS OR IMPLIED, INCLUDING ALL WARRANTIES OF MERCHANTABILITY AND/OR FITNESS FOR A PARTICULAR PURPOSE. TO THE EXTENT THAT ANY IMPLIED WARRANTIES MAY NONETHELESS EXIST BY OPERATION OF LAW, ANY SUCH WARRANTIES ARE LIMITED TO THE DURATION OF THIS WARRANTY. SOME STATES/PROVINCES DO NOT ALLOW LIMITATIONS ON HOW LONG AN IMPLIED WARRANTY LASTS, SO THE ABOVE LIMITATIONS MAY NOT APPLY TO YOU. LIMITATION OF LIABILITY REPAIR OR REPLACEMENT OF THIS PRODUCT, AS PROVIDED HEREIN, IS YOUR EXCLUSIVE REMEDY. DYCONN SHALL NOT BE LIABLE FOR ANY SPECIAL, INCIDENTAL OR CONSEQUENTIAL DAMAGES, INCLUDING, BUT NOT LIMITED TO, LOST REVENUES, LOST PROFITS, LOSS OF USE OF ANY SPECIAL, INCIDENTAL OR CONSEQUENTIAL DAMAGES, INCLUDING, BUT NOT LIMITED TO, LOST REVENUES, LOST PROFITS, LOSS OF USE OF SOFTWARE LOSS OR RECOVERY OF DATA, RENTAL OF REPLACEMENT EQUIPMENT, DOWNTIME, DAMAGE TO PROPERTY, AND THIRD-PARTY CLAIMS, ARISING OUT OF ANY THEORY OF RECOVERY, INCLUDING WARRANTY, CONTRACT, STATUTORY OR TORT. NOTWITHSTANDING THE TERM OF ANY LIMITED WARRANTY OR ANY WARRANTY IMPLIED BY LAW, OR IN THE EVENT THAT ANY LIMITED WARRANTY FAILS OF ITS ESSENTIAL PURPOSE, IN NO EVENT WILL DYCONN'S ENTIRE LIABILITY EXCEED THE PURCHASE PRICE OF THIS PRODUCT. SOME STATES/PROVINCES DO NOT ALLOW THE EXCLUSION OR LIMITATION OF INCIDENTAL OR CONSEQUENTIAL DAMAGES, SO THE ABOVE LIMITATION OR EXCLUSION MAY NOT APPLY TO YOU. THIS WARRANTY GIVES YOU SPECIFIC LEGAL RIGHTS AND YOU MAY ALSO HAVE OTHER RIGHTS THAT VARY FROM STATE TO STATE AND PROVINCE TO PROVINCE.

## Technical Support

For technical support, call 1-(855) 839-2666. You may also reach Dyconn technical support at [info@dyconn.com](mailto:info@dyconn.com)